

# New autonomous vehicles at IMR

Jan Arne Vågenes Fartøyinstrument



**AUV - Autonomous Underwater Vehicle**

**USV - Unmanned Surface Vehicle**

# Munin+

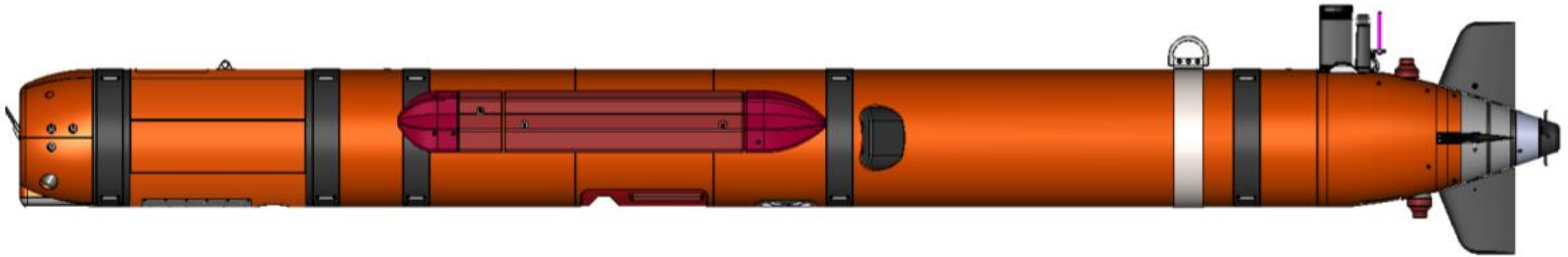

## Tekniske data

Length: 5.4 meter

Weight: 870 kg

Depth rating: 1500 meter

Survey speed: 3-4 knop

Batterikapasitet: 19.8 kWh, >24 timer @ 3 knop

Charging: 2 timer (0-90%)



## Nyttelast (Payload sensors)

- EM2040M – multistråle ekkolodd
- HISAS 2040 - Høyoppløst Interferometrisk Syntetisk Aperture Sonar, Range Independent Resolution
- Edgetech Sub-Bottom Profier (SBP)
- Cathx Ocean stillbildekamera

# Munin+

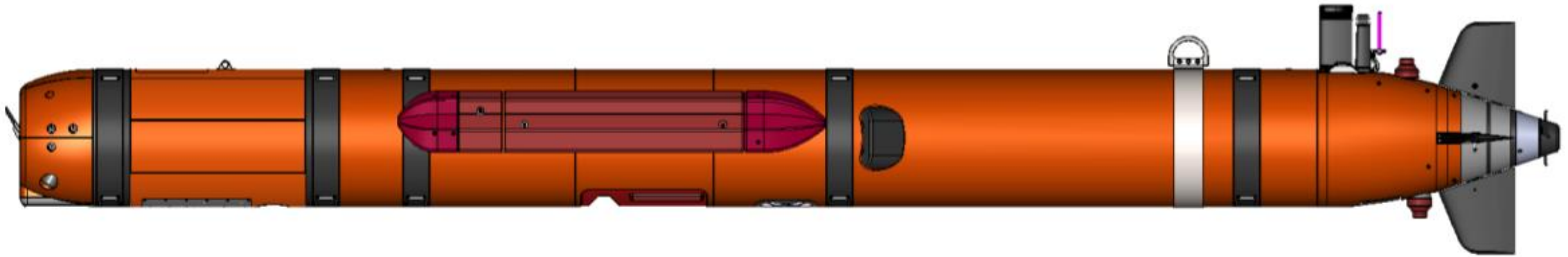

F

E

D

C

B

A



# Munin+



F

E

D

C

B

A

## **A Tail section:**

The Tail section holds the **propulsion system**, Depth and CT sensors, **antennas** (RF, GPS, Iridium and WLAN), cNODE **acoustic link system**, Recovery strobe light, **Drop weight unit** and On/Off magnetic switch.



# Munin+



F

E

D

C

B

A

## **B Energy section:**

The Energy section is a watertight section containing up to 12 **Battery modules** with internal electronics for charging and safety circuitry, with a communication link to the Battery control station (BCS). Buoyancy elements, **Trim weights and Trim bladders** can be installed on each side of the Energy section to adjust buoyancy of the AUV.



# Munin+



F

E

D

C

B

A

## **C Navigation/Payload section:**

The Navigation/Payload section is a watertight section containing the payload and control system electronics and processing units, Inertial measurement unit, Doppler velocity log, **EM 2040M** sonar head and **HISAS 2040** arrays.



# Munin+



F

E

D

C

B

A

## **D Forward endcap section:**

The Forward endcap section is a watertight section containing electronics related to the LED panel and **Swappable NAS**. An On/Off magnetic switch is installed on the Forward endcap section.



# Munin+



F

E

D

C

B

A

## **E Wet payload section:**

The Wet payload section supports the installation of various sensors and watertight equipment.

- Edgetech **Sub-Bottom Profier** (SBP)
- Cathx Ocean **stillbildekamera**





# Munin+

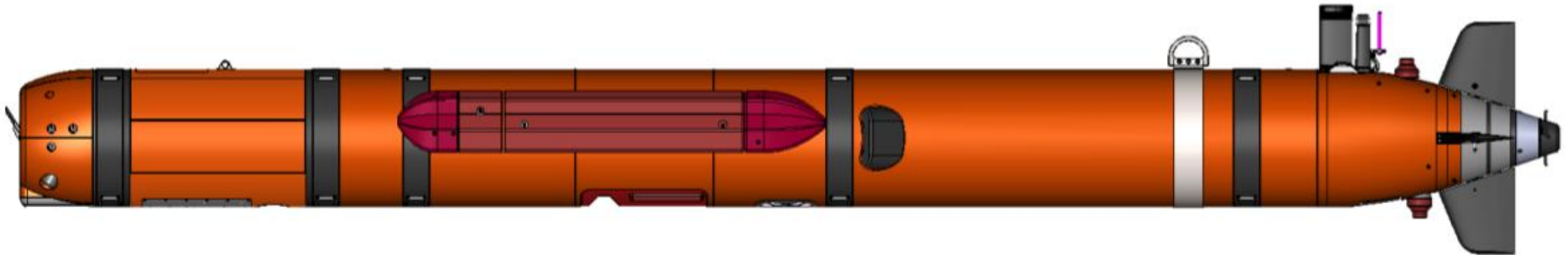

F

E

D

C

B

A

## **F Nose section:**

The Nose section holds units required for **vehicle recovery** (Lifting bail, Drop nose), collision avoidance sensors (**Forward looking sonars**), data download port and the **LED panel** for the Underwater camera.



# Munin+ Top side rack

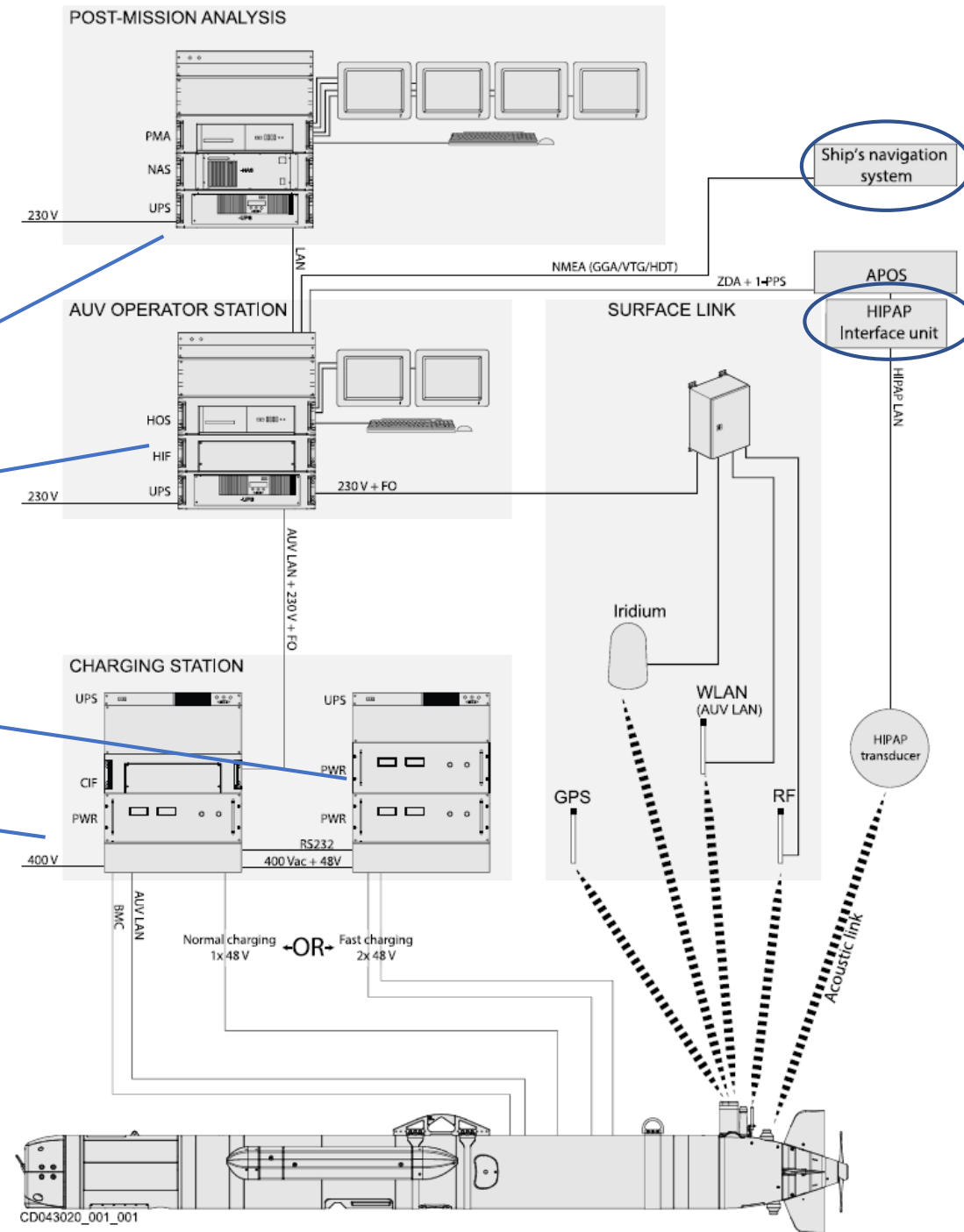

**Kontroll  
kontainer**



# Stinger for launch and recovery

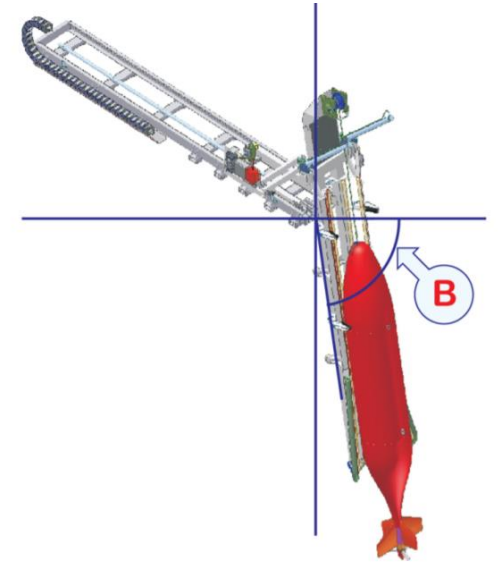
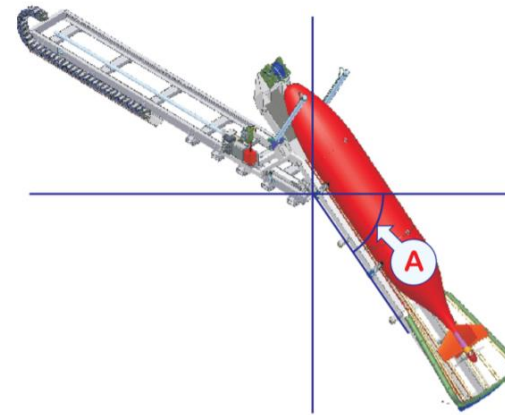
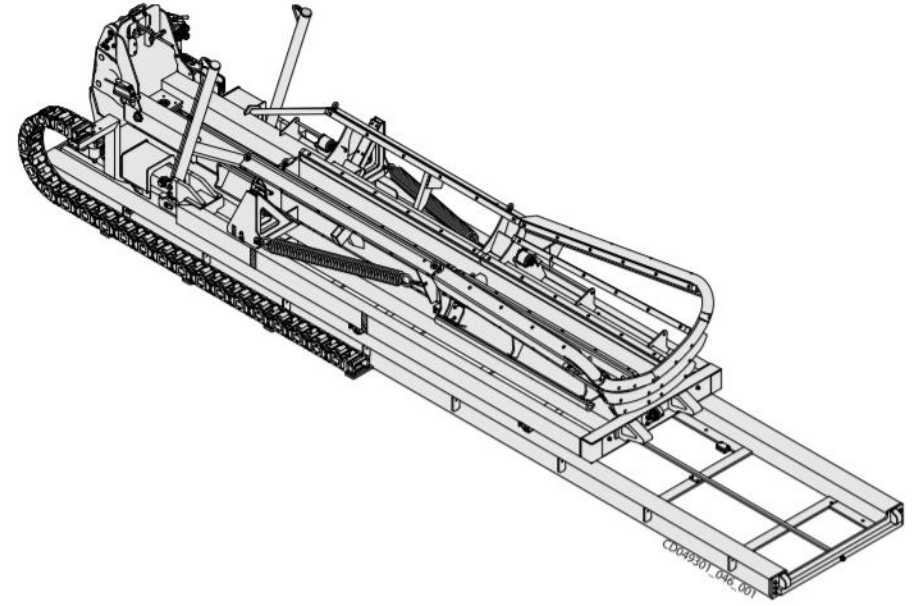

# Munin+ swath width

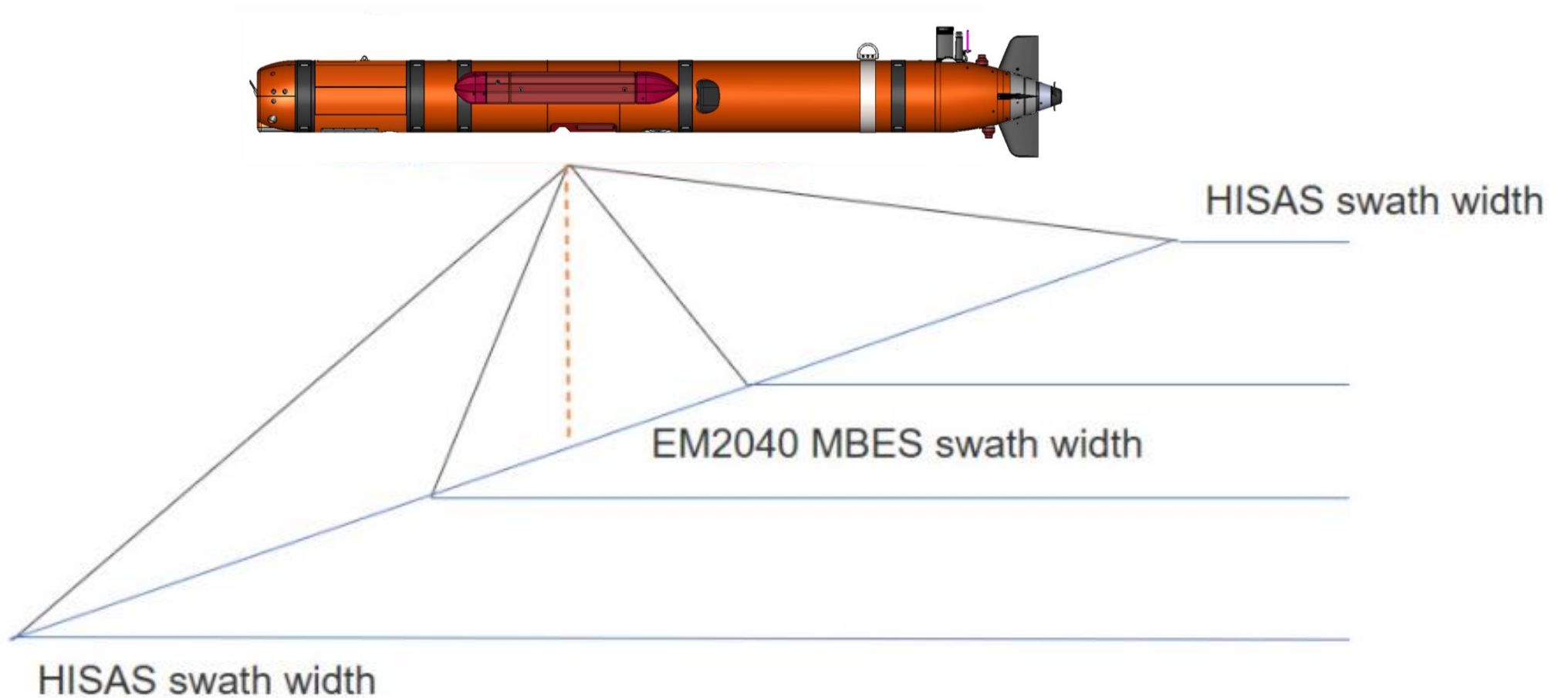

HISAS 2040 has a practical resolution of 5cm x 5cm at all ranges.  
HISAS 2040 har en range (pr side) @4 knop og 20 meter over bunn på 125m.  
EM2040 swath dekning på ca 135 grader

# Testing of Munin+ and stinger on «Tyra»



# Testing of Munin+ and stinger on «Hydrograf»



# Kontroll container



# Testing of Munin+ and stinger on «Johan Hjort»

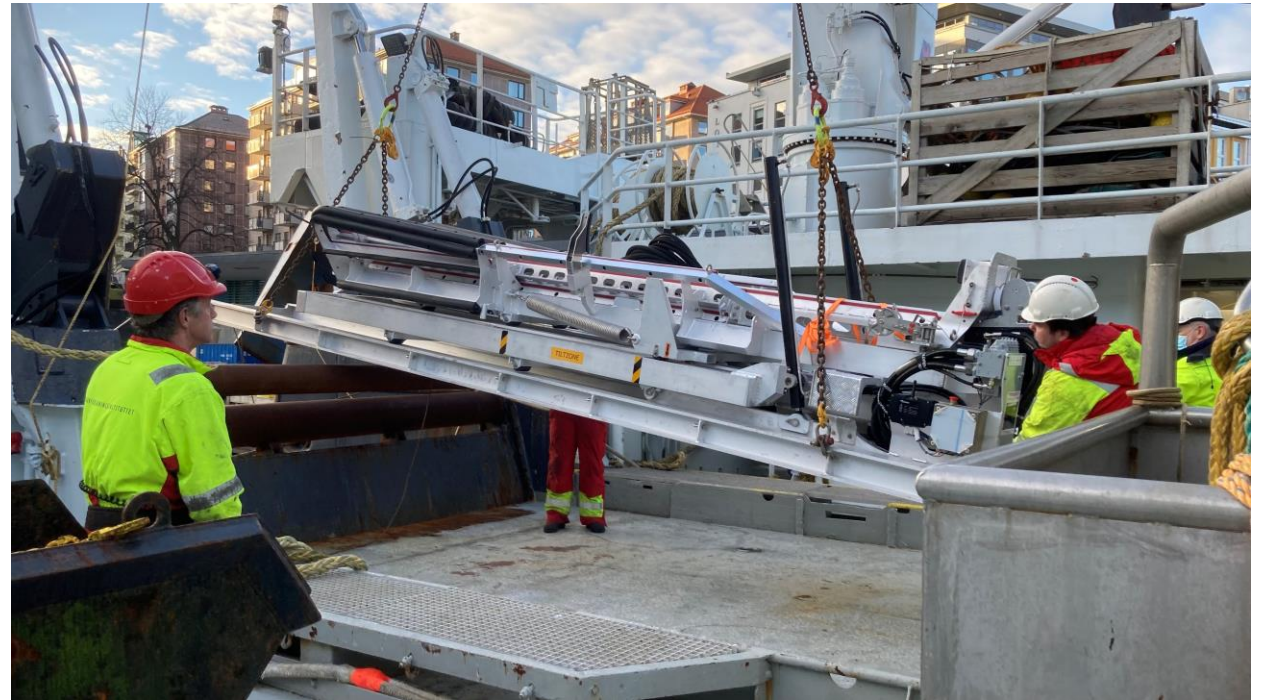



# Testing of Munin+ and stinger on «G.O.Sars»

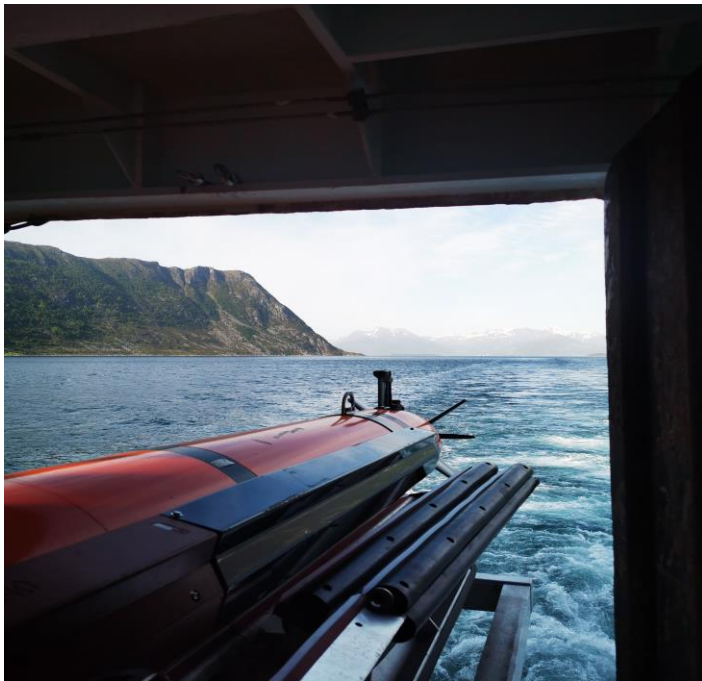

# Testing of Munin+ and stinger on «KH»

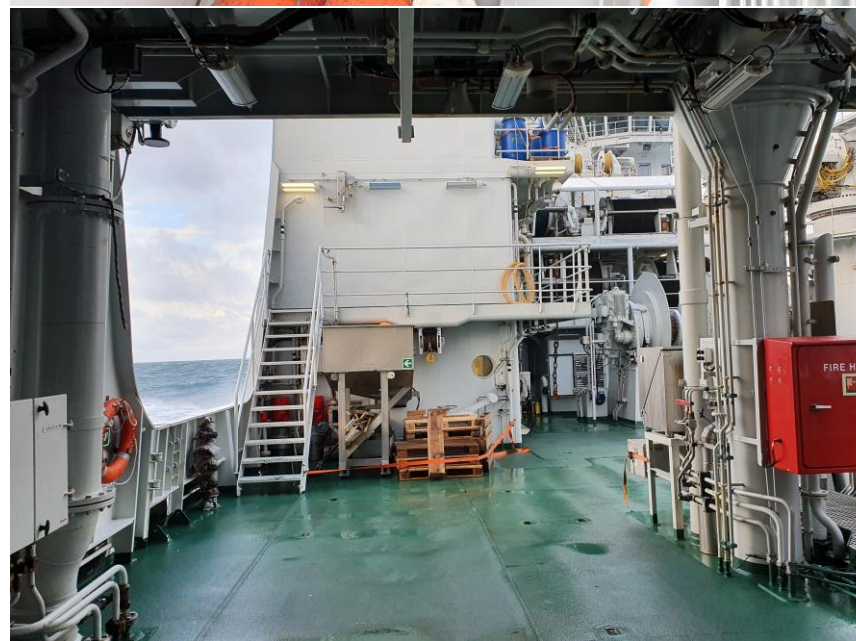

# Munin+ Mission planning SW

AUV (1) New Vehicle Commands

Mission Plan



No:Tag	Depth	Alt	DMO	Latitude	Longitude	Course	GMO	RPM	Speed	SMo	Dur	Dist	Flags
# AUV i vannet, skip ut av farkostens planlegde kurs													
1:start	0.0	20.0	D			050	C	0	=	R	1:30	-	
# MUNIN akselererer med kurs 180 grader. Bro med. Verifiser at EM er standby													
2:aksele	=	=	=	=	=	=	=	250	=	=	1:00	-	
# dykk til mellomdybde, verifiser hipap og ellers ingen feilmeldinger													
3:dive	20.0	=	=	=	=	=	=	=	=	2.00	S	1:00	- EMOn
# MUNIN mot havbunnen og følger denne.													
4:dive2	20.0	=	T	=	=	=	=	=	=	=	1:00	-	
5:	=	=	=	=	=	=	=	=	=	=	0:01	-	EM400Int
6:	=	=	=	=	=	=	=	=	=	=	0:01	-	DistTrigger
7:	=	=	=	=	=	=	=	=	=	=	0:01	-	SASPowerOn
8:	=	=	=	=	=	=	=	=	=	=	0:01	-	ETPowerOn
9:	=	=	=	=	=	=	=	=	=	=	0:01	-	SASOn
10:	=	=	=	=	=	=	=	=	=	=	0:01	-	SASHighPower
11:	=	=	=	=	=	=	=	=	=	=	0:01	-	ETOn
12:	=	=	=	58°30.705'N	008°55.629'E	=	=	=	=	=	=	=	
13:	=	=	=	58°30.801'N	008°55.857'E	(051)	=	=	=	=	(2:21)	(283)	
14:	=	=	=	58°30.969'N	008°55.843'E	(358)	=	=	=	=	(2:36)	(313)	
15:	=	=	=	58°31.109'N	008°56.213'E	(054)	=	=	=	=	(3:41)	(443)	
16:	150.0	=	=	58°30.973'N	008°56.554'E	(127)	=	=	=	=	(3:28)	(416)	
17:	=	=	=	58°31.043'N	008°57.273'E	(079)	=	=	=	=	(5:55)	(711)	
18:	20.0	=	=	58°31.220'N	008°57.660'E	(049)	=	=	=	=	(4:09)	(499)	
19:	=	=	=	58°31.214'N	008°58.179'E	(091)	=	=	=	=	(4:12)	(505)	
20:	=	=	=	58°31.175'N	008°58.178'E	(181)	=	=	=	=	(0:35)	(71)	
21:	=	=	=	58°31.004'N	008°57.697'E	(236)	=	=	=	=	(4:42)	(565)	
22:	=	=	=	58°30.789'N	008°57.543'E	(200)	=	=	=	=	(3:33)	(427)	
23:	=	=	=	58°30.796'N	008°57.401'E	(275)	=	=	=	=	(1:09)	(139)	
24:	=	=	=	58°31.012'N	008°57.290'E	(345)	=	=	=	=	(3:27)	(415)	
25:	=	=	=	58°30.978'N	008°56.892'E	(261)	=	=	=	=	(3:15)	(392)	
26:	=	=	=	58°30.864'N	008°56.607'E	(233)	=	=	=	=	(2:53)	(348)	
27:	=	=	=	58°30.809'N	008°56.221'E	(255)	=	=	=	=	(3:14)	(389)	
28:	=	=	=	58°30.699'N	008°55.928'E	(234)	=	=	=	=	(2:55)	(351)	
29:	=	=	=	58°30.737'N	008°55.853'E	(314)	=	=	=	=	(0:50)	(101)	
30:	=	=	=	58°30.933'N	008°56.143'E	(038)	=	=	=	=	(3:49)	(460)	

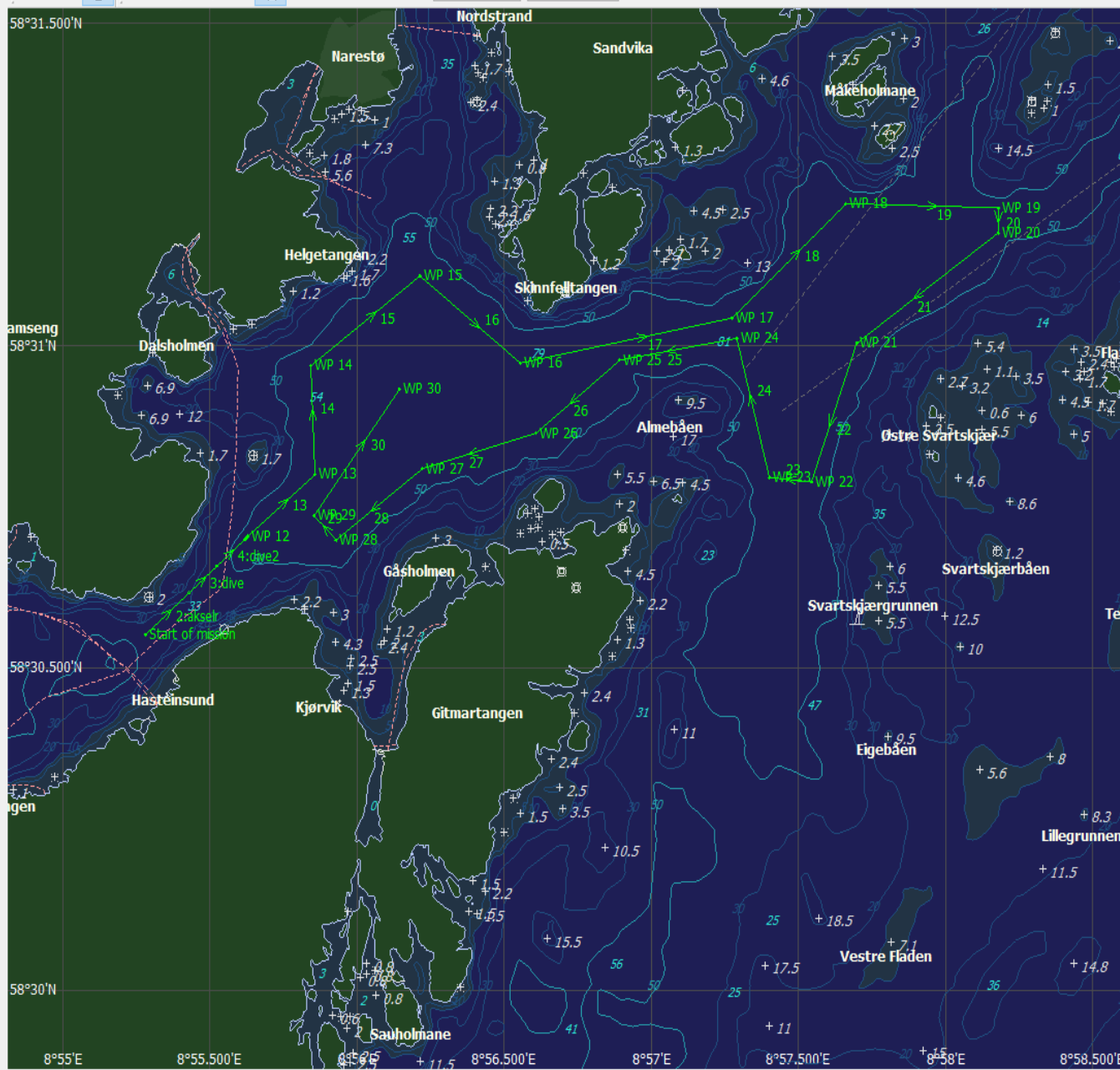
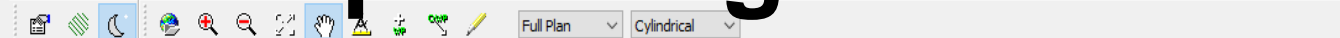

# Munin+ Reflection post processing SW

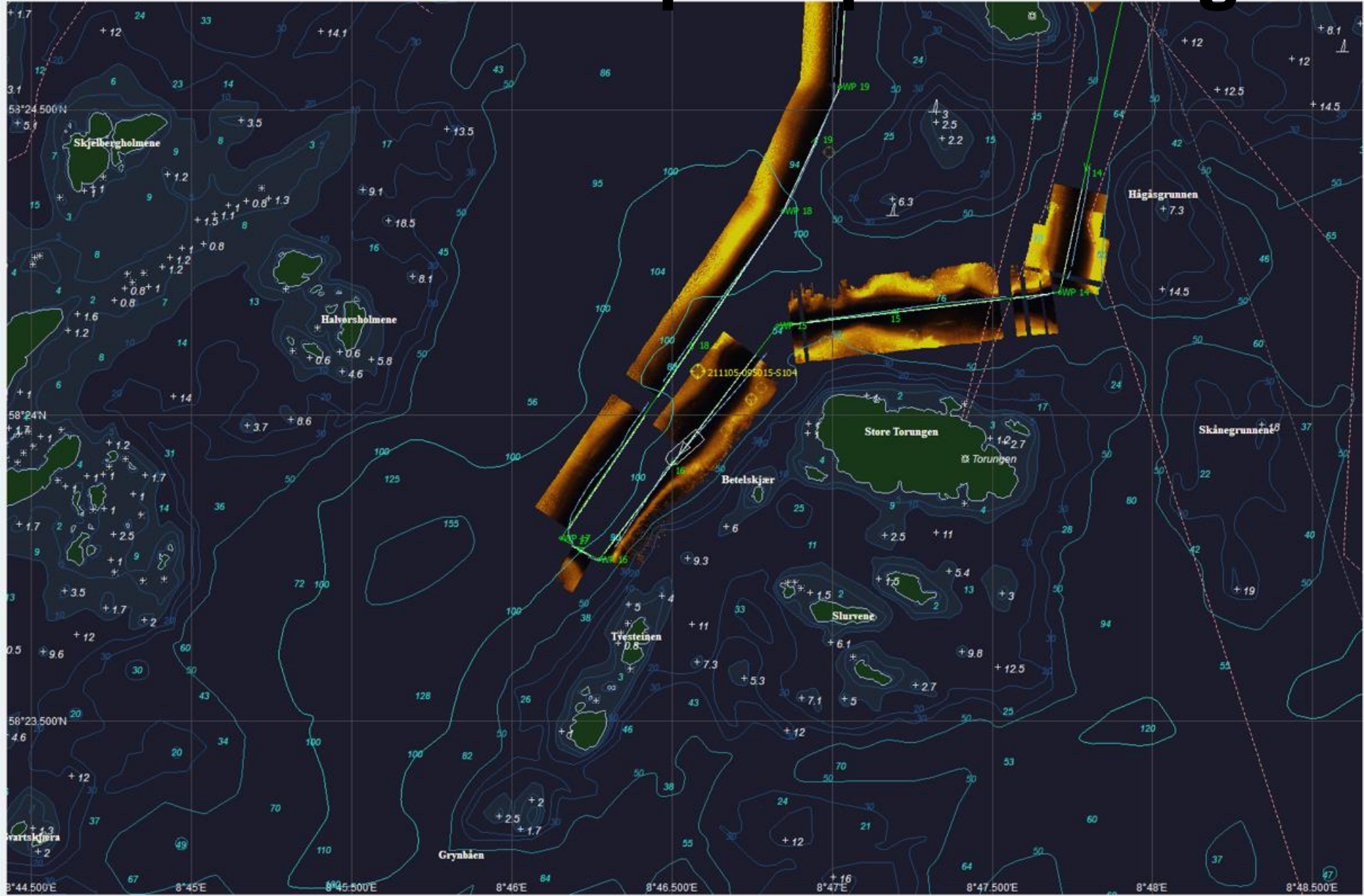

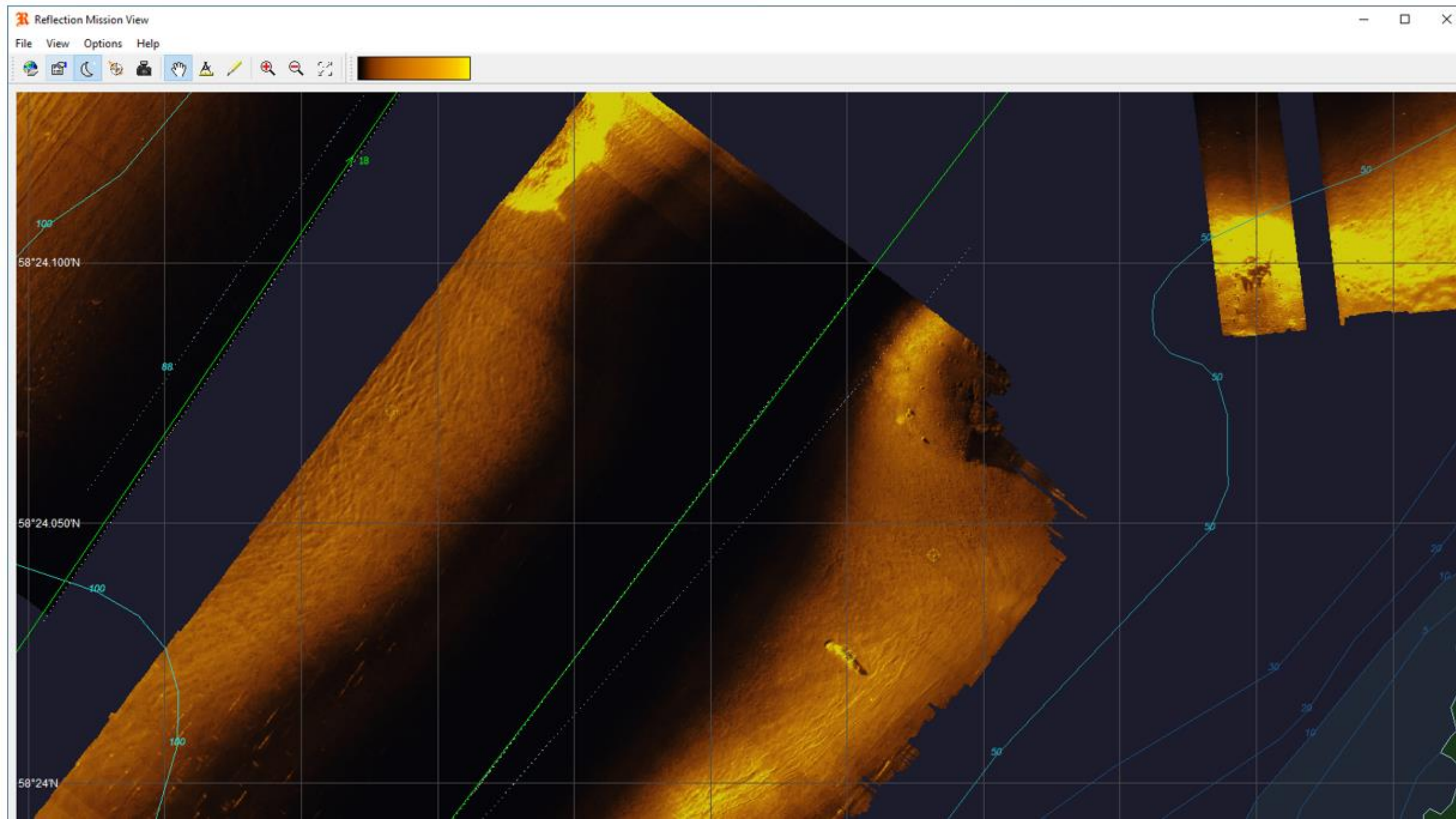

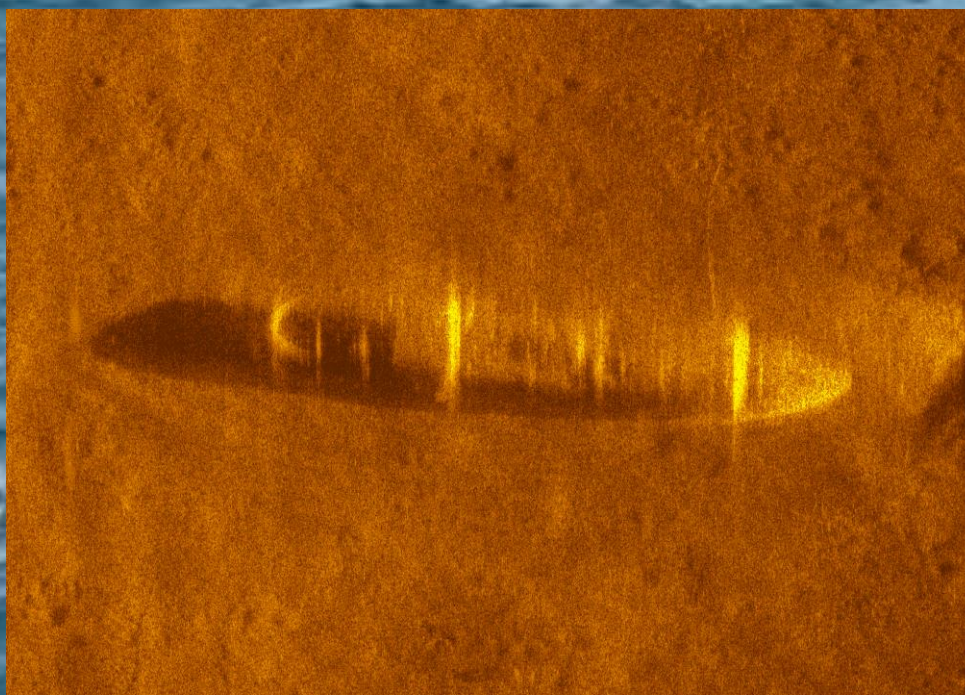
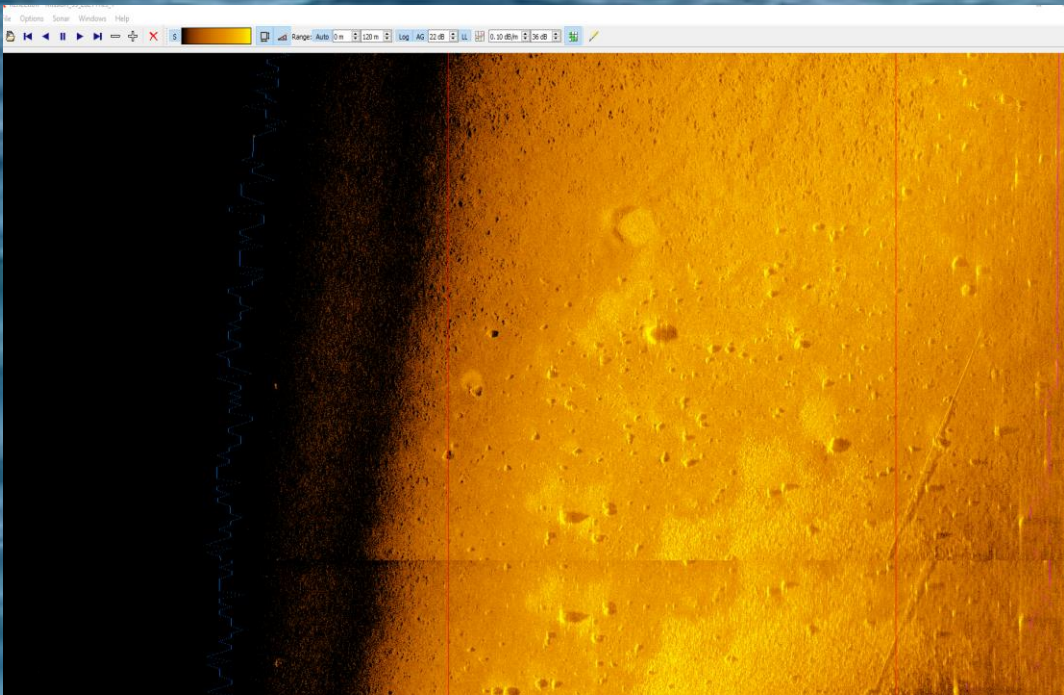
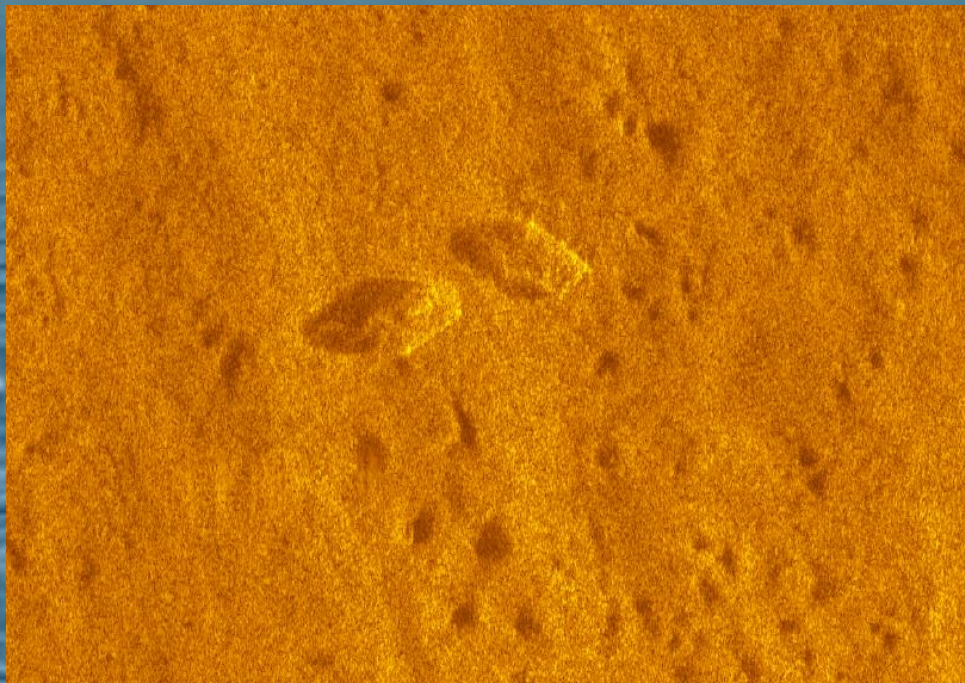
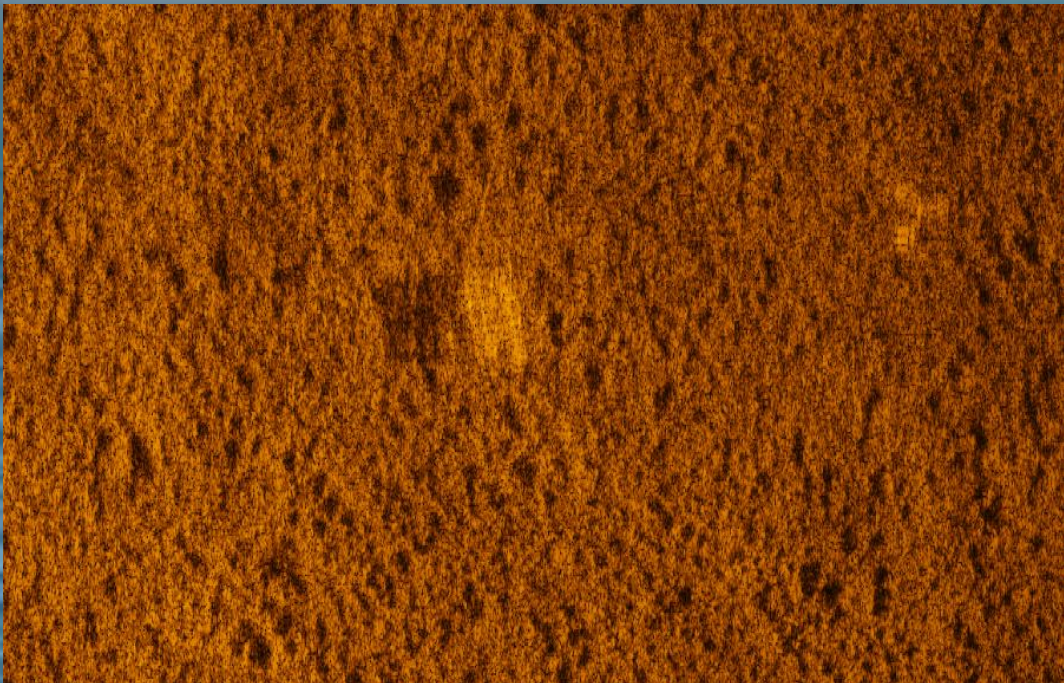

# Sounder



## Tekniske data

Skrog: glassforsterket plast (GPR)

Produsent: VIKING Norsafe

Lengde: 8 meter

Vekt: 5000 kg

Fremdrift: 110kW/145bhp Steyr  
diesel motor

Survey hastighet: 4-8 knop (13 knop  
max)

Rekkevidde: 20 dager @4 knop  
(2x400 liter tank)

Kan kjøres autonomt eller fjernstyres



- Levering 19 september 2022

## Payload sensors:

- EK80 - fiskeri ekkolodd
- ADCP 150kHz
- EM2040 – multibeam sonar \*
- Topas PS 120 \*
- \* opsjon

## Andre sensorer:

- Remote operated CTD vinsjeløsning
- Værstasjon (temp, trykk, vind)

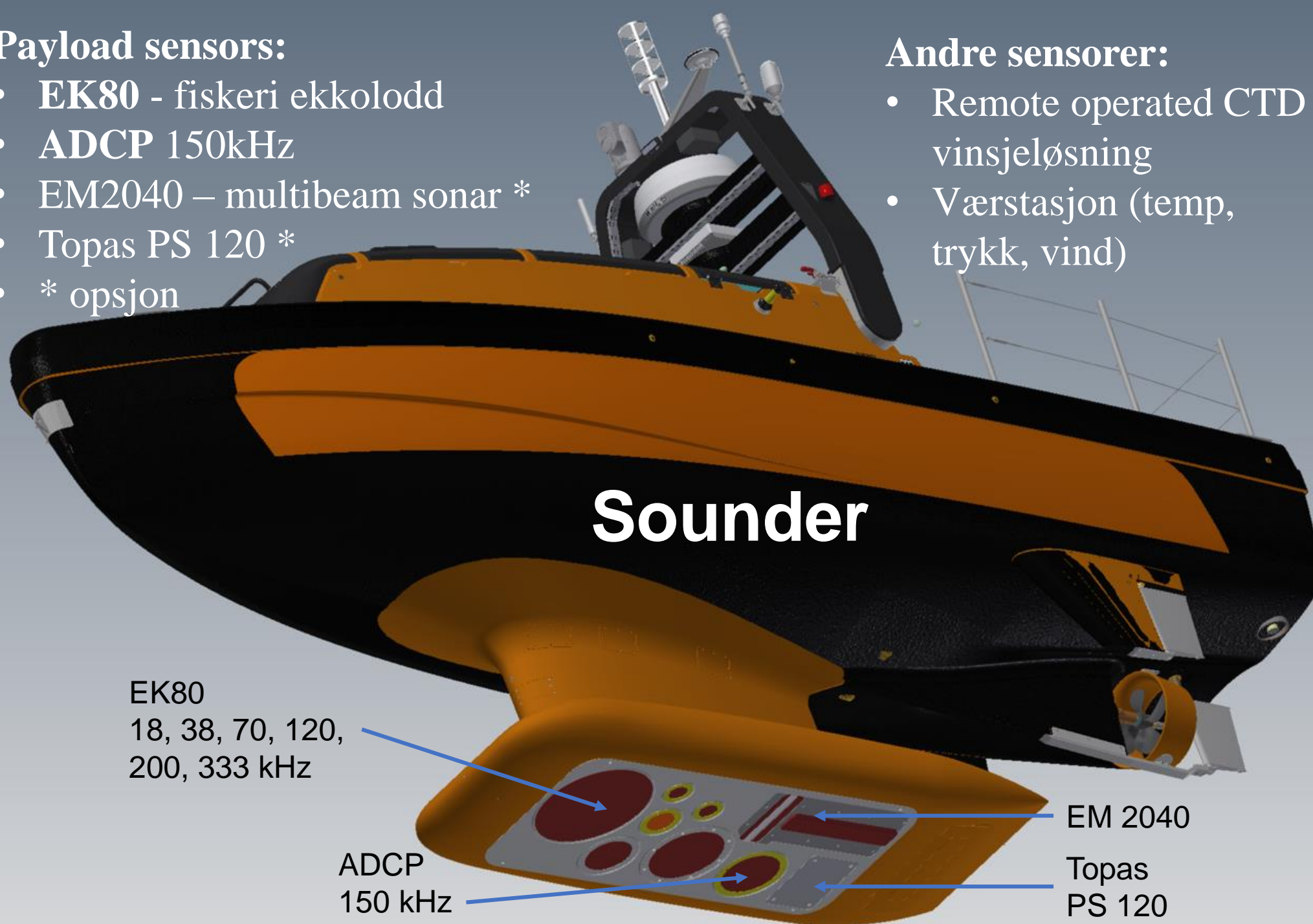

EK80  
18, 38, 70, 120,  
200, 333 kHz

ADCP  
150 kHz

EM 2040

Topas  
PS 120





# Sounder

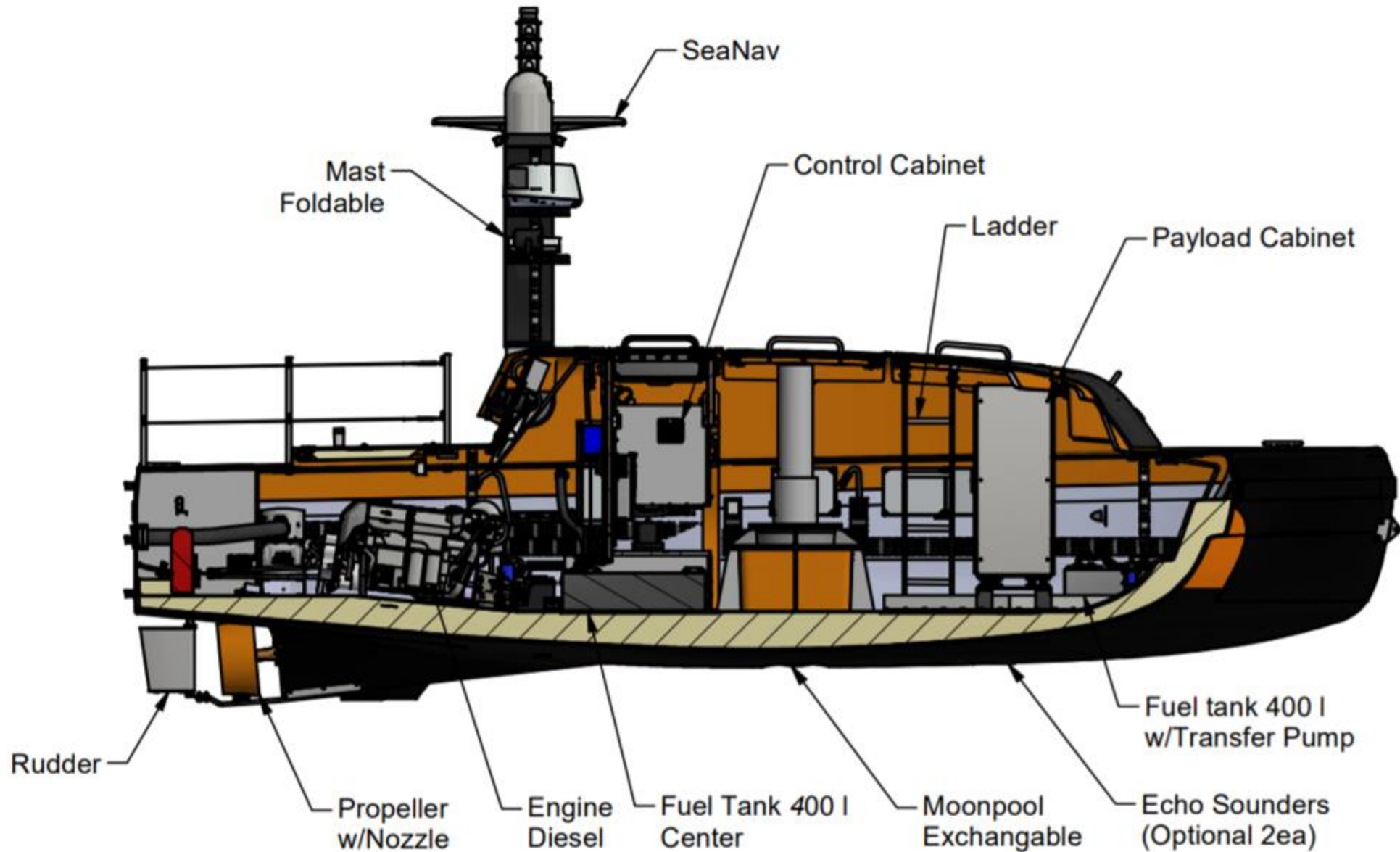

# Sounder «båtkrybbe»



# Experiences so far

We had some problems at the beginning with diving in good weather when there were no waves.  
We had to use a boat to create waves so that the craft would dive.  
The solution to this problem was to run full rudder up until you have the right speed, and then full rudder down.  
We and Kongsberg have tested this several times with 100% success  
The AUV is also wildly sensitive when it comes to balancing in salt water.  
Sometimes there may be less salt in the water in the end of the mission, then it may sink again.

We also had some problems with different layers in the water.  
Our first deep water dive did not go quite to plan as the craft detected bottom in the various layers.  
The solution is to set a value for the deepest layer in the configuration before the dive.  
We check this by taking a CTD

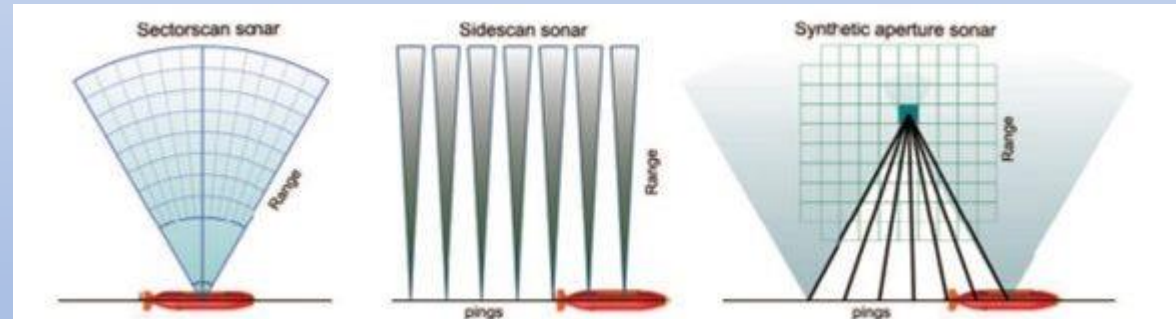

<https://www.kongsberg.com/no/maritime/products/ocean-science/mapping-systems/sonars/SAS/>



